

***Agilent Vector Network Analyzer
Receiver, Dynamic Accuracy***
(Linearity Over Its Specified Dynamic Range)

Specifications and Uncertainties

Edition, September 13, 2011

N5247-90003



Agilent Technologies

Notices

© Agilent Technologies, Inc. 2011

No part of this manual may be reproduced in any form or by any means (including electronic storage and retrieval or translation into a foreign language) without prior agreement and written consent from Agilent Technologies, Inc. as governed by United States and international copyright laws.

Manual Part Number

N5247-90003

Edition

Edition, September 13, 2011

Printed in USA

Agilent Technologies, Inc.
1400 Fountaingrove Pkwy
Santa Rosa, CA 95403

Warranty

The material contained in this document is provided “as is,” and is subject to being changed, without notice, in future editions. Further, to the maximum extent permitted by applicable law, Agilent disclaims all warranties, either express or implied, with regard to this manual and any information contained herein, including but not limited to the implied warranties of merchantability and fitness for a particular purpose. Agilent shall not be liable for errors or for incidental or consequential damages in connection with the furnishing, use, or performance of this document or of any information contained herein. Should Agilent and the user have a separate written agreement with warranty terms covering the material in this document that conflict with these terms, the warranty terms in the separate agreement shall control.

Technology Licenses

The hardware and/or software described in this document are furnished under a license and may be used or copied only in accordance with the terms of such license.

DFARS/Restricted Rights Notice

If software is for use in the performance of a U.S. Government prime contract or sub-contract, Software is delivered and licensed as “Commercial computer software” as defined in DFAR 252.227-7014

(June 1995), or as a “commercial item” as defined in FAR 2.101(a) or as “Restricted computer software” as defined in FAR 52.227-19 (June 1987) or any equivalent agency regulation or contract clause. Use, duplication or disclosure of Software is subject to Agilent Technologies’ standard commercial license terms, and non-DOD Departments and Agencies of the U.S. Government will receive no greater than Restricted Rights as defined in FAR 52.227-19(c)(1-2) (June 1987). U.S. Government users will receive no greater than Limited Rights as defined in FAR 52.227-14 (June 1987) or DFAR 252.227-7015 (b)(2) (November 1995), as applicable in any technical data.

Safety Notices

The following safety notes are used throughout this document. Familiarize yourself with each of these notes and its meaning before performing any of the procedures in this document.

CAUTION

A **CAUTION** notice denotes a hazard. It calls attention to an operating procedure, practice, or the like that, if not correctly performed or adhered to, could result in damage to the product or loss of important data. Do not proceed beyond a **CAUTION** notice until the indicated conditions are fully understood and met.

WARNING

A **WARNING** notice denotes a hazard. It calls attention to an operating procedure, practice, or the like that, if not correctly performed or adhered to, could result in personal injury or death. Do not proceed beyond a **WARNING** notice until the indicated conditions are fully understood and met.

Measurement Errors	6
S-Parameter Measurement Errors	7
Systematic Errors	8
Directivity Errors (Reducible)	9
Tracking Errors (Reducible)	9
Source and Load Match Errors (Reducible)	9
Dynamic Accuracy Errors (Usually Not Reducible)	9
Random Errors	10
Noise Errors	10
Connector Repeatability Errors	10
Cable Stability Errors	10
Drift & Stability Errors	10
Receivers	11
Contributors of Receiver Linearity Errors	12
Receiver Operating Regions	14
Receivers Operating in the High Signal Level Region (Compression)	15
Receiver Compression Region	15
Receivers Operating in the Low Signal Level Region (Noise & Crosstalk)	16
Receivers Operating in the Linear Region (Most Desired)	17
Receiver Linearity Measurement Methods	18
ADC Linearity Improvement Using Dither Technique	18
Measurements vs. Contributions of Noise & Crosstalk	20
References	21



Vector Network Analyzer Measurements

A Vector Network Analyzer (VNA) can be used to measure devices, components, and networks; commonly referred to as the *device under test*. The device under test may consist of components that behave linearly (such as: filters, amplifiers, cables, or couplers) or non-linearly (such as: diodes, mixers, or non-linear amplifiers).

Stimulus/Response Test System

- is a system where a Stimulus signal is applied and a Response is measured in regards to the Stimulus that is applied.

The measurements that are made characterize the device under test's Response to the applied Stimulus.

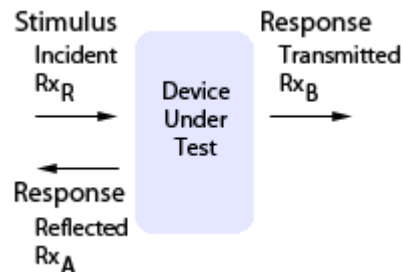

Vector Network Analyzers may be thought of in terms of a *Stimulus/Response Test System*. In this type of a test system, a signal source is used to produce a Stimulus signal. This Stimulus signal is then injected (applied) to a device under test.

Receivers, inside the network analyzer, are used to measure this applied Stimulus signal as well as to measure the Response signals that are produced from the device under test.

In network analyzer terms, these measured signals are referred to as the **Incident signal** (Stimulus being applied), the **Transmitted signal** (the amount of the Stimulus signal that is actually transmitted through the device under test), and the **Reflected signal** (the amount of the Stimulus signal that is reflected back from the input of the device under test because of impedance mismatches).

$$\text{Transmission} = \text{Transmitted Signal} / \text{Incident Signal} \quad (1)$$

Transmission Measurements include: Gain/Loss, S-Parameters: S21, S12, Transmission Coefficient, Insertion Phase, Group Delay, and Attenuation

$$\text{Reflection} = \text{Reflected Signal} / \text{Incident Signal} \quad (2)$$

Reflection Measurements include: Return Loss, S-Parameters: S11, S22, Reflection Coefficient, Impedance $R+jX$, VSWR

Where:

Rx_R is a receiver that measures the Incident (Stimulus) signal; this is the Reference signal that Transmitted and Reflected signals are compared against.

Rx_B is a receiver that measures the Transmitted (Response) signal.

Rx_A is a receiver that measures the Reflected (Response) signal.



Measurement Errors

Measurement Uncertainty - is the probability distribution of Measurement Errors.

A **probability distribution** - is a function that describes the probability of obtaining a certain outcome where the outcomes are not equally likely. There may be a probability of getting each outcome, but the probabilities are not necessarily equal.

The probability distribution can be thought of as a bell-curve chart, where the most probable things are in the middle of the bell curve.

Vector Network Analyzer measurements of a device under test, have errors that are caused by imperfections within the network analyzer; these errors are referred to as measurement errors.

Measurement Errors can be classified into three groups:

- Systematic
- Random
- Drift & Stability

The total amount of these Measurement Errors can be represented as:

$$\begin{aligned} \text{Total Measurement Errors (Worst Case)} \\ = \text{Systematic Errors} + \text{Random Errors} + \text{Drift \& Stability Errors} \end{aligned} \quad (3)$$

Figure 1 Signal Flow Graph Representation of Vector Network Analyzer Error Corrected Measurement Error Model

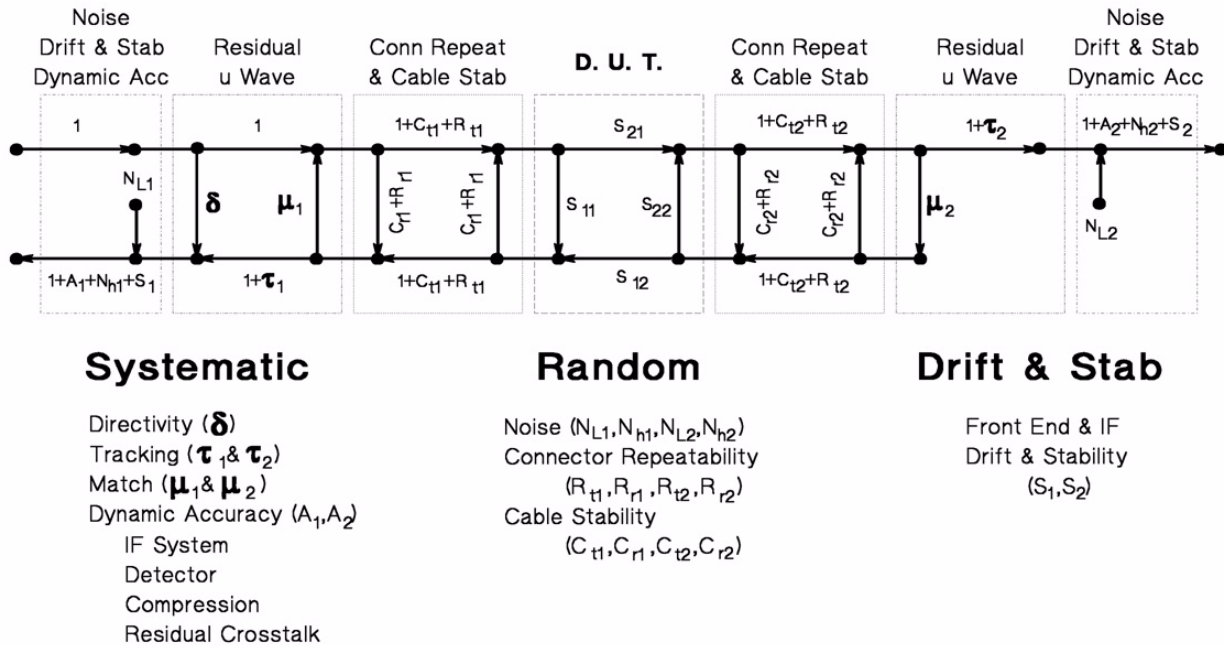

S-Parameter Measurement Errors

The following equations show how S-Parameter Measurement Errors, shown in [Figure 1](#) on page 6, can be expressed as functions of Systematic, Random, and Drift & Stability Errors.

NOTE

Important!

Receiver Dynamic Accuracy is one of many possible Systematic Errors.

Since S-Parameter Measurement Errors already account for Noise Error, the *Receiver Linearity* specification, which is a key component of *Receiver Dynamic Accuracy*, need not include the impact of Noise Error again.

For more details, see [“Measurements vs. Contributions of Noise & Crosstalk”](#) on page 20.

$$\Delta S_{11(\text{mag})} = \sqrt{(\text{Systematic} + \text{Stability})^2 + \text{Noise}^2}$$

$$\Delta S_{11(\text{phase})} = \sin^{-1} \left(\frac{\sqrt{(\text{Systematic} + \text{Stability})^2 + \text{Noise}^2}}{S_{11}} \right) + 2C_{\text{TP1}}$$

$$\Delta S_{21(\text{mag})} = \sqrt{(\text{Systematic} + \text{Stability})^2 + \text{Noise}^2}$$

$$\Delta S_{21(\text{phase})} = \sin^{-1} \left(\frac{\sqrt{(\text{Systematic} + \text{Stability})^2 + \text{Noise}^2}}{S_{21}} \right) + C_{\text{TP1}} + C_{\text{TP2}}$$

C_{TPi} = cable phase stability and connector repeatability at port i

Systematic $\Delta S_{11a} \approx \pm \delta \pm \tau_1 S_{11a} \pm \delta_{22} S_{21a} S_{12a} \pm \mu S_{11a}^2 \pm A_1 S_{11a}$
 Systematic $\Delta S_{21a} \approx x_2 \pm S_{21} (\tau_2 \pm \mu_1 S_{11} \pm \mu_2 S_{22} \pm \mu_1 \mu_2 S_{21} S_{12} \pm A_2)$
 $A_i \equiv$ dynamic accuracy of i receiver

When making measurements, there are various measurement errors that have to be taken into account. Some of these measurement errors can be corrected and reduced from the measurement and some of them cannot.

Measurement Errors can be corrected and reduced from the measurement by performing an appropriate system calibration to determine these Systematic Errors. See [2], under "References" on page 21.

Table 1 Measurement Errors that Can/Cannot Be Corrected/Reduced

Measurement Errors that Can Be Corrected/Reduced	Measurement Errors that Cannot Be Corrected/Reduced
<ul style="list-style-type: none"> • Directivity • Tracking • Port Match • Main Leakage Paths 	<ul style="list-style-type: none"> • Noise and Residuals • Drift after Error-Correction - or environmental errors are those associated with temperature, humidity, pressure, or other factors related to time. • Stability After Error-Correction • Repeatability of Connectors • Leakage Paths not included in error model • Some Errors of Calibration Standards • Some Receiver Linearity

Systematic Errors

Systematic Errors - are stable, repeatable, predictable, and they can be quantified and corrected.

Residual Systematic Errors - may still be left over even after a measurement calibration.

Systematic Errors are caused by imperfections in the network analyzer and test setup and can be characterized:

- repeatable (and therefore predictable), and are assumed to be time invariant (output does not depend explicitly on time)
- can be characterized during the calibration process and mathematically reduced during measurements
- **are never completely removed**
There are always some residual errors due to limitations in the calibration process. The *residual* (after measurement calibration) Systematic Errors result from:
 - imperfections in the calibration standards
 - connector repeatability and errors of calibration standard definition (model)
 - stability and repeatability of interconnecting cables
 - instrumentation drift

Systematic Errors include:

- "Directivity Errors (Reducible)"
- "Tracking Errors (Reducible)"
- "Source and Load Match Errors (Reducible)"
- "Dynamic Accuracy Errors (Usually Not Reducible)"

Directivity - is the vector sum of all signals reaching Test Receiver before the device under test.

Reflection Tracking - is the differences in frequency response between Reference and Test Receivers.

Source Match - is from impedance mismatches at the device under test looking back into the source.

Load Match - is from impedance mismatches at the output port of the device under test looking into Port 2 of the Vector Network Analyzer.

Dynamic Accuracy - is one of the Systematic Errors in a Vector Network Analyzer receiver and may be defined as the linearity of a receiver over its specified Dynamic Range.

Dynamic Accuracy is usually specified in dB of error for a given input power level (dBm).

Directivity Errors (Reducible)

Directivity errors limit the ability to measure a low reflection signal. In the case of measuring Reflection Coefficient and Return Loss of a device under test, Directivity is a crucial parameter in the uncertainty of the result.

Tracking Errors (Reducible)

Frequency Response Reflection Tracking (R_{X_A}/R_{X_R}) this error occurs because the signal path of Receiver A (R_{X_A}) does not completely track the signal path of the Reference Receiver (R_{X_R}).

Frequency Response Transmission Tracking (R_{X_B}/R_{X_R}) this error occurs because the signal path of Receiver B (R_{X_B}) does not completely track the signal path of the Reference Receiver (R_{X_R}).

Source and Load Match Errors (Reducible)

Source Match (Mismatch) or ($Z_{Source} \neq Z_0$) Ideally in reflection measurements, all of the signal that is reflected off of the device under test is measured at Receiver A (R_{X_A}).

In reality, some of the signal reflects off the device under test and is then reflected off of the source port and other internal reflections that are not captured by Receiver A (R_{X_A}) and the reference receiver (R_{X_R}).

Load Match (Mismatch) or ($Z_{Source} \neq Z_0$) Ideally in transmission measurements, an incident signal is transmitted through the device under test and is measured at Receiver B (R_{X_B}).

In reality, some of the signal is reflected off of Port 2 and other components and is not measured at Receiver B (R_{X_B}).

Dynamic Accuracy Errors (Usually Not Reducible)

Dynamic Accuracy Errors may include the following:

- IF System Errors
- Detector Errors
- Compression Errors
- Residual Crosstalk Errors - occur as uncorrected leakage from one receiver signal path to another receiver signal path.

See "Receiver Operating Regions" on page 14.

Random Errors

Random Errors include:

- "Noise Errors"
- "Connector Repeatability Errors"
- "Cable Stability Errors"

Noise Errors

Noise Errors are random, unpredictable, and vary over time in a random fashion. Because of their random nature, they cannot be mathematically removed (or corrected) from a measurement like Systematic Errors; Noise Errors may be reduced by signal averaging.

Connector Repeatability Errors

Connector Repeatability Errors occur because of the random variations encountered when connecting a pair of RF or microwave connectors. Variations in both reflection and transmission can be observed. Connector repeatability errors limit the achievable accuracy of all measurements.

Cable Stability Errors

Cable Stability Errors are totally dependent on the quality of the test port cables used. Like connector repeatability errors, cable stability errors limit the achievable accuracy of all measurements.

Drift & Stability Errors

Drift & Stability Errors (shown as *Front End & IF* and *Drift and Stability in Figure 1*) are due to the network analyzer or test-system performance characteristics changing after a calibration has been performed.

The time frame over which a calibration remains accurate is dependent on the rate of drift that the test system undergoes in the test environment. Providing a stable ambient temperature usually minimizes Drift & Stability Errors. Drift & Stability Errors can also be minimized by recalibrating.

Receivers

Dynamic Accuracy of a Vector Network Analyzer is defined as the linearity of a **receiver** over its specified Dynamic Range.

A receiver consists of many components and can be shown as functional blocks. The functional blocks of typical Vector Network Analyzer receiver is shown in Figure 2.

Figure 2 Vector Network Analyzer Receiver Functional Blocks

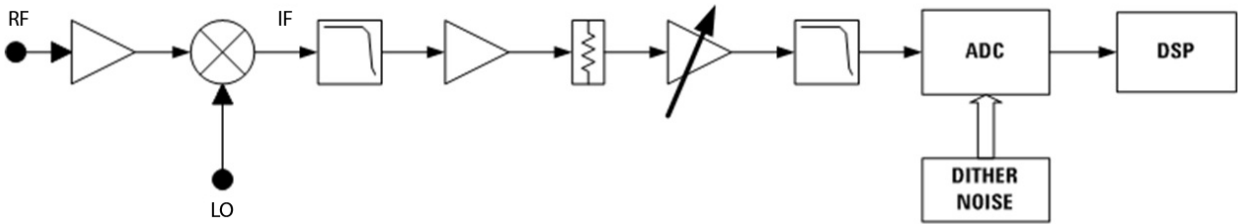

System Dynamic Range - is defined as the maximum leveled output power (spec) minus the noise floor (spec).

Receiver Dynamic Range - is defined as the test port compression at 0.1 dB (typical) minus the noise floor (typical).

Note that the Dynamic Range of a receiver is the input signal range that a receiver can be utilized in to measure a signal that is below the Compression region of the receiver and above the Noise & Crosstalk region.

Compression and Noise levels change (increase and decrease) as a function of frequency.

Figure 3 System Dynamic Range and Receiver Dynamic Range

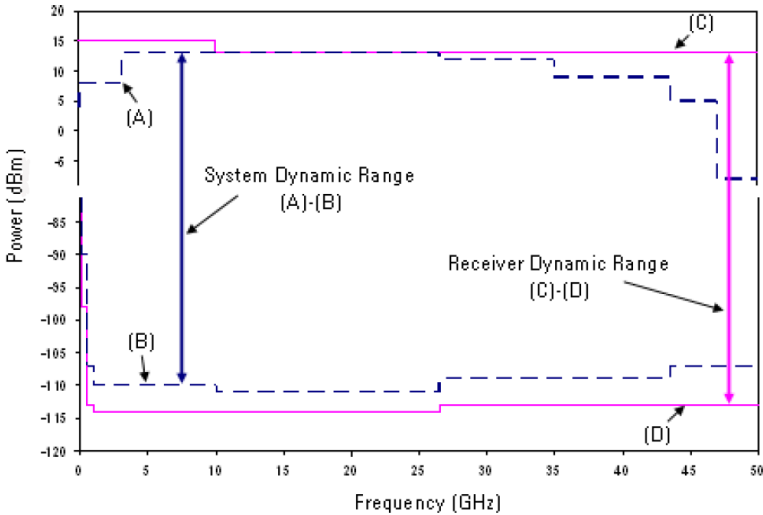

(A) represents an example of an upper limit line for maximum leveled output power (spec).
 (B) represents an example of a lower limit line for the system noise floor (spec).
 So, *System Dynamic Range* (A)-(B) represents the power vs. frequency response of maximum leveled output power (spec) minus the noise floor (spec).

(C) represents an example of an upper limit line for test port compression at 0.1 dB (spec).
 (D) represents an example of a lower limit line for the receiver noise floor (typical).
 So, *Receiver Dynamic Range* (C)-(D) represents the power vs. frequency response of the test port compression at 0.1 dB (spec) minus the noise floor (typical).

Contributors of Receiver Linearity Errors

Contributors of typical Vector Network Analyzer receiver linearity errors are shown in Figure 4

Figure 4 Contributors of Typical Vector Network Analyzer Receiver Linearity Errors

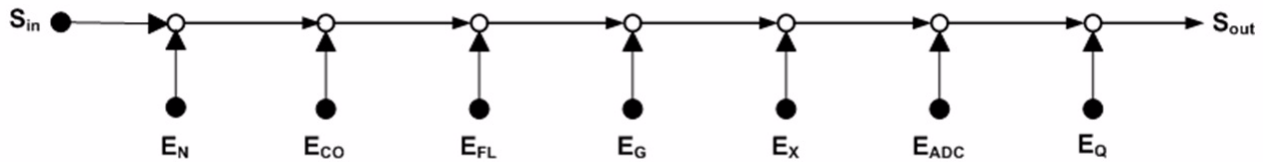

E_N = Noise Error

E_{CO} = Compression Error

E_{FL} = Filter Linearity Error

E_G = Gain Setting Error

E_X = Residual Crosstalk Error

E_{ADC} = Residual ADC Linearity Error

E_Q = ADC Residual Quantization Error

- **Noise Error (E_N)** - Noise Errors are random, unpredictable, and vary over time in a random fashion. Because of their random nature, they cannot be mathematically removed (or corrected) from a measurement like Systematic Errors; Noise Error may be reduced by signal averaging.
- **Compression Error (E_{CO})** - All amplifiers have nonlinear behavior. One way to describe that nonlinear behavior is in terms of compression.

Compression - may be described as a reduction in total receiver gain. This gain reduction usually occurs at high input signal levels.

In addition to any compression caused by the input amplifier, there may also be compression from the mixer, filter, or ADC. Regardless of the contributor of the nonlinearity, total compression is characterized during product qualification test. It is also tested per specification in factory test and field calibration. The compression error is accounted for separately as part of the Dynamic Accuracy model.

- **Filter Linearity Error (E_{FL})** - Discrete component filters are linear at low power levels. As power level increases, inductors can become nonlinear when their magnetic core becomes saturated.

Another possible cause of filter nonlinearity is Residual Crosstalk or coupling between inductors. Either case happens at higher power levels where the complete receiver's linearity is measured.

- **Gain Setting Error (E_G)** - Gain Setting Error is not a factor and is not a contributor of linearity signal processing errors!

Amplifier gain switching is designed to compensate for signal path loss variations over frequency. At any given frequency, the gain setting is not changed and therefore there is no error associated with gain setting.

- **ADC Linearity and Residual Quantization Error (E_{ADC})** - The ADC is guaranteed by its manufacturer to have integral linearity errors within a small amount, like a few LSB of an ADC's resolution. (For example, the LSB of a 14 bit ADC is one part in 214.)

Linearity of an ADC can be improved substantially, lower than a fraction of 1 LSB, by employing Dithering technique.

For example, with a 14 bit resolution ADC and pseudo-random noise Dither signal of 5.4% at 5 sigma of full scale, nonlinearity is negligible [2]. See "[ADC Linearity Improvement Using Dither Technique](#)" on page 18 for details.

Receiver Operating Regions

Since receivers are used to measure magnitude and phase response of a device under test, these measurements must be made at signal levels that are not too high that the receiver is in *Compression* and not so low that Noise & Crosstalk interferes with the signal being measured!

NOTE

Depending on the input signal level applied to a receiver, a receiver may be operating in one of three regions:

- Compression region
- Linear region; this is the most desired operating region!
- Noise & Crosstalk region

Operating Regions of a Receiver

- may be divided into three regions: the Compression region, the Linear region, and the Noise + Crosstalk region. Specifications for each region may be treated separately.

Linear Region - is when the network analyzer receiver is not operating in the Compression region and not operating close to the Noise Floor & Crosstalk regions.

The Linear region of a network analyzer receiver is the region of operation that produces a linear response output from a linear response change to the input.

Figure 5 Plot of an Receiver's Output Power vs. Input Power

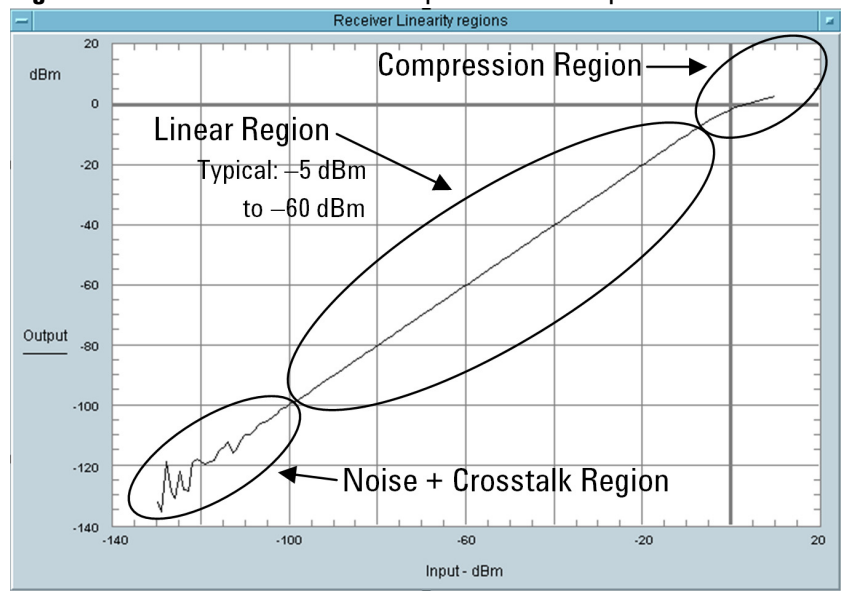

The Compression region and Noise & Crosstalk region changes (increases and decreases) as a function of frequency. See [Figure 3](#) on page 11.

Receivers Operating in the High Signal Level Region (Compression)

Receiver Compression - is the combined nonlinear behavior of the components in a receiver at high input signal levels.

At high signal levels, the receivers in a network analyzer may go into *Compression*.

Receivers have a region of linear gain, where the gain is independent of the signal level. As the input signal level to a receiver is increased to a level that causes the receiver to approach saturation, the gain will decrease, resulting in a large distorted signal response and receiver compression.

When a receiver is in compression, one or more of its components (Amplifier, Mixer, Filter, or ADC) can no longer track the changes of the input in a constant manner; this is a nonlinear condition.

Receiver Compression Region

Table 2 shows an example of how the compression specifications of a generic network analyzer may be stated. Other network analyzers may have the same or different specifications.

Table 2 Compression @8 dBm Test Port Power

Frequency Range	Compression
500 MHz to 16 GHz	<0.17 dB
16 GHz to 24 GHz	<0.23 dB
24 GHz to 26.5 GHz	<0.29 dB

Receivers Operating in the Low Signal Level Region (Noise & Crosstalk)

To Lower the Noise Floor

Use averaging or reduce the IF bandwidth; the drawback is that both of these techniques increase test times.

To Reduce Crosstalk

Crosstalk is not random like noise.

If Crosstalk level is above the Noise Floor level, it can be reduced by performing an isolation calibration.

Isolation is measured when the isolation standards are connected to the Vector Network Analyzer test ports. See [PNA Online Help](#) for more information.

At low signal levels, near the Noise Floor & Crosstalk region, the receivers in a network analyzer can make measurements, but are limited when signal levels are so low that noise from the receiver interferes with the measurement. The receiver can no longer distinguish between the noise and the actual signal being measured.

Each measured signal ($S_{ADC\ Out}$) is equal to the applied signal ($S_{Applied}$), plus a Dither signal (S_{Dither}), plus Noise error (E_{Noise}), plus Residual Crosstalk error ($E_{Crosstalk}$).

This can be represented with the following formula:

$$S_{ADC\ Out} = S_{Applied} + S_{Dither} + E_{ADC} + E_{Noise} + E_{Crosstalk} \tag{4}$$

Where:

$S_{ADC\ Out}$ is the ADC output signal

$S_{Applied}$ is the input signal that is applied to each receiver

S_{Dither} is a defined signal that is applied to the ADC to minimize ADC linearity error; it can be removed during signal processing.

E_{ADC} is the error of the ADC; this error is minimized by S_{Dither} .
(See "ADC Linearity Improvement Using Dither Technique" on page 18.)

E_{Noise} is a random level and is dependent on the selected bandwidth and Averaging; it varies with frequency.

$E_{Crosstalk}$ is the constant level of crosstalk; it varies with frequency.

Noise Error and Crosstalk Error are defined per Noise Floor and Residual Crosstalk specifications.

Both of the contributions for E_{Noise} and $E_{Crosstalk}$ are accounted for in the Measurement Error Model of [Figure 1](#).

Noise Floor on many network analyzers is a specified parameter. [Table 3](#) shows an example of how the Test Port Noise Floor specifications of a generic network analyzer may be stated. Other network analyzers may have the same or different specifications.

Table 3 Test Port Noise Floor

Description	Specification	Typical
500 MHz to 20 GHz	-114 dBm	-117 dBm
20 GHz to 24 GHz	-110 dBm	-115 dBm
24 GHz to 26.5 GHz	-107 dBm	-113 dBm

Receivers Operating in the Linear Region (Most Desired)

The Linear region is where the receiver in a network analyzer should provide the best *Dynamic Accuracy*. Typically, this Linear region covers the -5 dBm to -60 dBm input power range. Figure 6 shows plots of Dynamic Accuracy specifications that include the Compression region and the Noise & Crosstalk region.

Figure 6 Receiver Magnitude Dynamic Accuracy

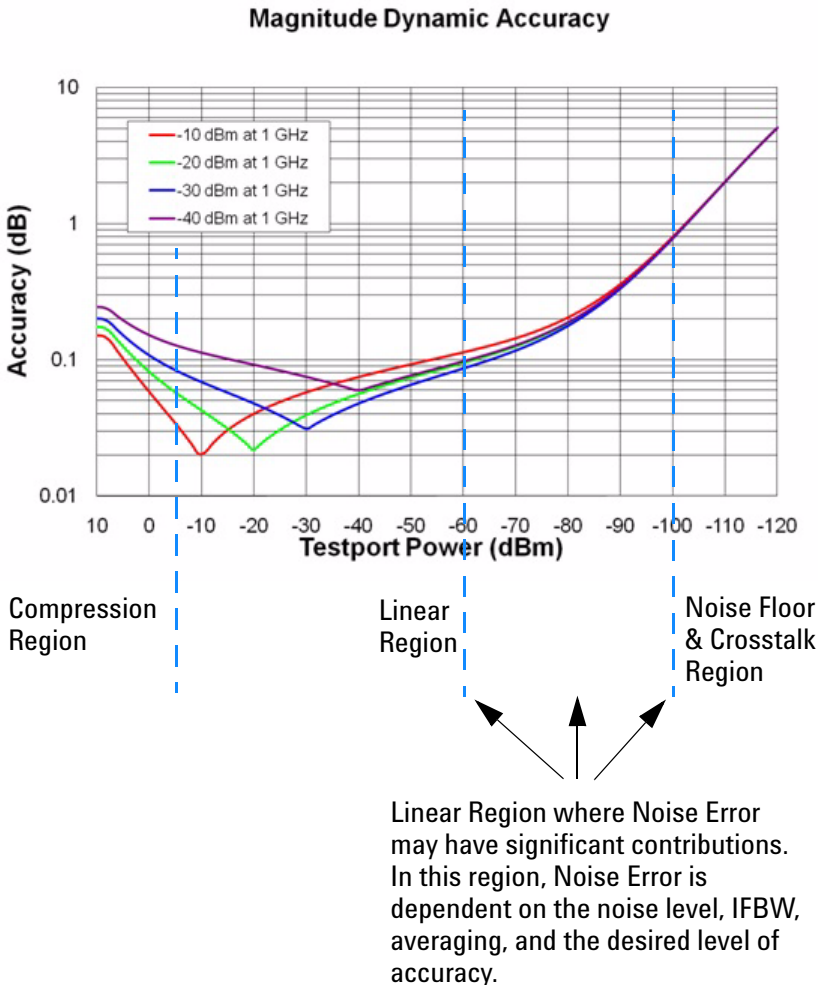

Receiver Linearity Measurement Methods

Typically, receiver linearity is measured by comparing the receiver's measured power change to a known level of power change. This defined power level change may be established by a precision power sensor, a precision AC voltmeter, a precision attenuator, or a precision power level signal generator.

Linearity may be defined as:

$$\left(\frac{\text{Power}_{\text{Measured}}}{\text{Power}_{\text{Measured Reference}}} \right) / \left(\frac{\text{Power}_{\text{Signal}}}{\text{Power}_{\text{Signal Reference}}} \right) \quad (5)$$

The reference power must be well defined and its linearity must be significantly better than the linearity of the receiver.

ADC Linearity Improvement Using Dither Technique

Linearity of the receiver at signal levels, below -40 dBm, depends solely on the linearity of the ADC in the receiver. Since a Dither signal is used to remove ADC linearity errors, it is linear by design and therefore, does not require further testing when signal levels are below -60 dBm!

Figure 7 shows the ideal transfer function of an analog-to-digital converter (ADC). It has a step change of error at the midpoint of the input voltage. This step change of error is known as *quantizing error* and is represented with the Δ symbol.

Figure 7 Ideal Transfer Function of ADC Quantizing Error

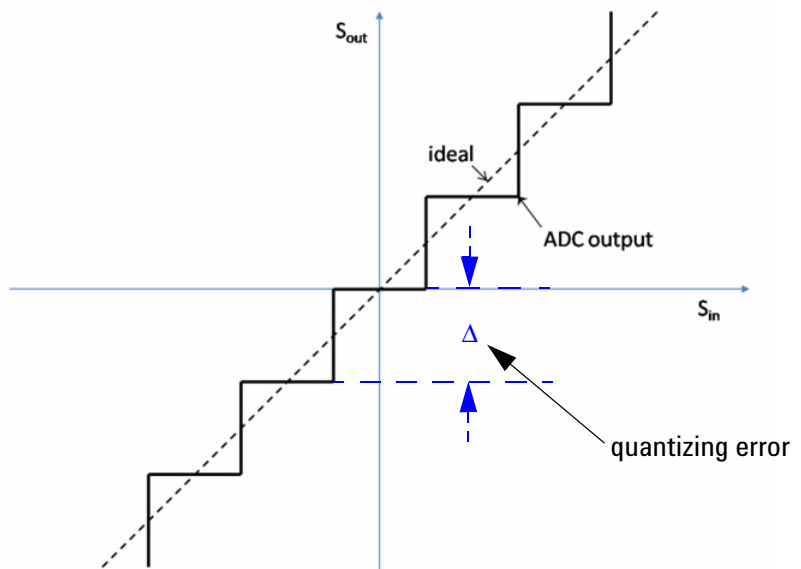

It has been demonstrated in [3], [4], and [5] that by adding a Dither signal to the input, the ADC's quantizing error can be minimized. For a Dither signal of the Gaussian form (the most natural and least sensitive to Dithering level changes and errors) the deviation of the averaged transfer characteristic from a straight line may be expressed as below for a Dithering signal with an amplitude standard deviation greater than 0.3 of the LSB:

Without Dithering, the quantizing error $q_e = \Delta/2 - \Delta \left(\frac{1}{\Delta} \left(s + \frac{\Delta}{2} \right) \right)$

where Δ = quantization step, s = signal

With Dithering, $\overline{m_e} \cong \frac{1}{\pi} e^{-2\pi^2(\overline{\sigma_d^2}/\Delta^2)} \sin(2\pi q_e)$

where $q_e = \frac{q_e}{\Delta}$; $\overline{\sigma_d}$ = standard deviation of the Gaussian dithering signal.

With a Dithering signal at 1.1% of full scale, $\frac{\overline{\sigma_d}}{\Delta} > 100$,

Therefore, deviation from a straight line, $\exp(-2\pi^2 10^4)$, is essentially zero.

At relatively large signal region to the level of dither noise, ADC's integral non-linearity (INL) cannot be cancelled. If the ADC has a manufacturer specification of +/-3-LSB INL, so in the worst case the error at a full-scale input of ADC would be less than

$$1 / 2^{14} * 3 * 2 \text{ (bipolar scaling)} \approx 370 \text{ [ppm]} \approx 3 \text{ [mdB]}$$

This is negligibly small compared to a typical receiver compression error at large signal region. Also this error element would be tested with receiver compression test.

Measurements vs. Contributions of Noise & Crosstalk

Dynamic Accuracy of a receiver consists of three regions: Compression, Linear, and Noise & Crosstalk. Both the Compression region and Noise & Crosstalk region are specified separately. At low signal levels, the linearity of a receiver depends solely on the linearity of the ADC. Using a dithering technique, this ADC linearity error is reduced to practically zero.

A receiver's Measured Power is composed of the Signal Power applied to the input of the receiver and is added to the Noise Power, any residual Crosstalk Power, and the error in the measurement; this is shown with the following formula:

$$Power_{Measured} = Power_{Signal} + Power_{Noise} + Power_{Crosstalk} + Error_{Measurement} \quad (6)$$

Since Noise Power and residual Crosstalk Power are specified (and are available from Data Sheets), their contributions to Measured Power can be calculated with the above equation.

Table 4 shows how Measured Power is impacted by Noise Power and residual Crosstalk Power.

Table 4 Worst Case Measurement Error Caused by Noise Power & Residual Crosstalk Power

Noise Power (dBm)	-110			
Residual Crosstalk Power (dBm)	-130			
IFBW	10 Hz		1 kHz	
Signal Power (dBm)	RMS	Peak	RMS	Peak
-50	0.000004	0.000006	0.000043	0.000061
-60	0.000044	0.000061	0.000435	0.000609
-70	0.000439	0.000614	0.004345	0.006082
-80	0.004384	0.006137	0.043257	0.060440
-90	0.043644	0.060979	0.414322	0.569582
-100	0.417873	0.574379	3.012471	3.804645
-110	3.031961	3.827373	10.417873	11.764964
-120	10.453230	11.801259	20.047512	21.496501
-130	20.086002	21.535100	30.008677	31.468719

Low Power Threshold Level (-60 dBm)
*is a function of the actual noise floor
 and crosstalk levels of the instrument
 at the frequency of interest along with
 the uncertainty of the linearity
 measurement system.*

Typically residual Crosstalk Power level is below Noise Power level, so its contribution to measurement uncertainty is less significant. [Table 4](#), shows that at -60 dBm Signal Power, the Noise & Residual Crosstalk contributions are 0.000609 dB peak with a 1 kHz IFBW setting.

At -60 dBm (and below) Signal Power level, the Noise & Residual Crosstalk contributions become more significant relative to other sources of measurement errors < 0.001 dB which makes this Signal Power level the lowest input Signal Power level where meaningful linearity measurements can be made. Measurements below this Signal Power level are simply measuring noise variability rather than the true linearity of the receiver!

If Noise Power level is reduced substantially by using significantly more signal averaging, meaningful linearity measurements may be made on even lower input Signal Power levels. However, this will significantly increase test time and system drift error.

Since the receiver is linear by design at these lower Signal Power levels, there is no need to measure linearity below the threshold level of -60 dBm Signal Power. Making linearity measurements above this threshold level and below receiver compression level are sufficient to warrant linearity performance of a receiver.

References

- [1] D. Rytting, "Network Analyzer Accuracy Overview", 58th ARFTG Conference Digest, Nov. 29, 2001
- [2] Agilent AN 1287-3, "Applying Error Correction to Network Analyzer Measurements", March 27, 2002
- [3] P. Carbone, D. Petri, "Effect of Additive Dither on the Resolution of Ideal Quantizers", IEEE Transactions on Instrumentation and Measurement, Vol. 43, No. 3, June 1994 pp.389-396
- [4] B. Brannon, "Overcoming Converter Nonlinearities with Dither", Analog Devices AN-410
- [5] M.F. Wagdy, "Effect of Various Dither Forms on Quantization Errors of Ideal A/D Converters", IEEE Transactions on Instrumentation and Measurement, Vol. 38, No. 4, August 1989, pp 850-855
- [6] Ken Wong, "VNA Receiver Dynamic Accuracy Specifications and Uncertainties - A Top Level Overview", White Paper, June 25, 2010

Edition, September 13, 2011

[N5247-90003](#)

